



CABINETS, COUNTERTOPS & MORE



☎ 346-582-3082  
✉ [upccmore@gmail.com](mailto:upccmore@gmail.com)  
📍 1325 Main St. Suite 303  
Katy, TX 77494  
🌐 [www.upcabinetscountertops.com](http://www.upcabinetscountertops.com)

# PRIME SERIES



Frost White



Soft Ash



Timber Wood



Dark Gray



Dirt Grey



Royal Blue



Mint



Cream White



Ebony Black



Slim White

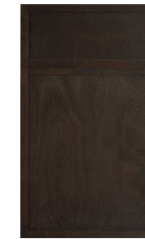

Slim Brown



Ivory White



Raised White



Sage Green



Dovetail Drawer



Solid Wood Door & Face Frame



6-way European Hidden Hinge



Under-mounted Soft Close Slide



Full Extension Concealed Drawer Glide

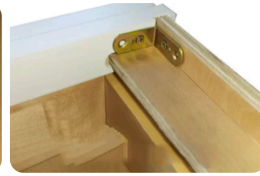

Metal Bracket Reinforcement

- Solid wood door frames are mortise and tenon.
- 6-way adjustable concealed hinge with build-in soft close 110° opening capability.
- 5/8" solid birch dovetail drawer with a 3/8" plywood bottom with full extension under mount soft slides.
- 4" interior drawer height.
- 3/4" X 1 1/2" solid wood face frame.
- 1/2" select birch veneered plywood back with a nature finished interior.
- 1/2" select birch veneered plywood side panels splined into face frame.
- 3/4" select birch veneered plywood adjustable shelving.
- Base cabinet has 18" deep shelves.



CABINETS, COUNTERTOPS & MORE

04

05

SINGLE DOOR BASE CABINET	ITEM	Description	L (in.)	W (in.)	H (in.)	Cubic Feet (ft <sup>3</sup> ) /CTN	Lb/CTN
	BF0924	Standard Base - Full Height Door only - 09"W x 34-1/2"H x 24"D	36 1/4	25 1/2	4 1/4	2.32	30.86
	B12	Standard Base - 1 Door & 1 Drawer - 12"W x 34-1/2"H x 24"D	36 1/4	25 1/2	4 1/2	2.43	49.05
	B15	Standard Base - 1 Door & 1 Drawer - 15"W x 34-1/2"H x 24"D	36 1/4	25 1/2	4 1/2	2.43	50.71
	B18	Standard Base - 1 Door & 1 Drawer - 18"W x 34-1/2"H x 24"D	36 1/4	25 1/2	5	2.64	56.00
	B21	Standard Base - 1 Door & 1 Drawer - 21"W x 34-1/2"H x 24"D	36 1/4	25 1/2	5	2.64	60.96
DOUBLE DOOR BASE CABINET	ITEM	Description	L (in.)	W (in.)	H (in.)	Cubic Feet (ft <sup>3</sup> ) /CTN	Lb/CTN
	B24	Standard Base - 2 Door & 1 Drawer - 24"W x 34-1/2"H x 24"D	37 3/4	26 1/4	5	2.82	66.25
	B27	Standard Base - 2 Door & 1 Drawer - 27"W x 34-1/2"H x 24"D	36 1/4	29 1/4	5	3.01	70.66
	B30	Standard Base - 2 Door & 1 Drawer - 30"W x 34-1/2"H x 24"D	36 1/4	32	5	3.31	76.06
	B33	Standard Base - 2 Door & 1 Drawer - 33"W x 34-1/2"H x 24"D	36 1/4	32	5	3.31	82.67
	B36	Standard Base - 2 Door & 1 Drawer - 36"W x 34-1/2"H x 24"D	37 3/4	32	5	3.45	86.53
DOUBLE DOOR BASE CABINET	ITEM	Description	L (in.)	W (in.)	H (in.)	Cubic Feet (ft <sup>3</sup> ) /CTN	Lb/CTN
	B39	Standard Base - 2 Door & 2 Drawer - 39"W x 34-1/2"H x 24"D	40 3/4	32	5	3.72	99.65
	B42	Standard Base - 2 Door & 2 Drawer - 42"W x 34-1/2"H x 24"D	43 3/4	32	5	3.99	104.28
THREE DRAWERS BASE CABINET	ITEM	Description	L (in.)	W (in.)	H (in.)	Cubic Feet (ft <sup>3</sup> ) /CTN	Lb/CTN
	DB12	Drawer Base - 3 Drawer - 12"W x 34-1/2"H x 24"D	36 1/4	25 1/2	5 3/4	3.06	75.73
	DB15	Drawer Base - 3 Drawer - 15"W x 34-1/2"H x 24"D	36 1/4	25 1/2	5 3/4	3.06	81.13
	DB18	Drawer Base - 3 Drawer - 18"W x 34-1/2"H x 24"D	36 1/4	25 1/2	5 3/4	3.06	87.74
	DB21	Drawer Base - 3 Drawer - 21"W x 34-1/2"H x 24"D	37 3/4	26 1/4	5 3/4	3.27	92.59
	DB24	Drawer Base - 3 Drawer - 24"W x 34-1/2"H x 24"D	37 3/4	29	6 1/2	4.11	101.96
	DB27	Drawer Base - 3 Drawer - 27"W x 34-1/2"H x 24"D	37 3/4	31	6 1/2	4.39	109.02
	DB30	Drawer Base - 3 Drawer - 30"W x 34-1/2"H x 24"D	36 1/4	32	6 1/2	4.37	114.42
	DB33	Drawer Base - 3 Drawer - 33"W x 34-1/2"H x 24"D	36 1/4	32	6 1/2	4.37	120.48
DB36	Drawer Base - 3 Drawer - 36"W x 34-1/2"H x 24"D	37 3/4	32	6 1/2	4.56	128.64	

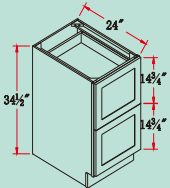
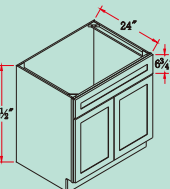
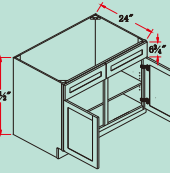
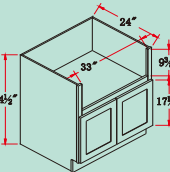
TWO DRAWERS BASE CABINET		ITEM	Description	L (in.)	W (in.)	H (in.)	Cubic Feet (ft <sup>3</sup> ) /CTN	Ib/CTN
	DB24-2	Drawer Base - 2 Drawer - 24"W x 34-1/2"H x 24"D	37 3/4	29	5 3/4	3.61	102.63	
	DB30-2	Drawer Base - 2 Drawer - 30"W x 34-1/2"H x 24"D	36 1/4	32	5 3/4	3.84	112.77	
SINK BASE CABINET		ITEM	Description	L (in.)	W (in.)	H (in.)	Cubic Feet (ft <sup>3</sup> ) /CTN	Ib/CTN
	SB24	Sink Base - 2 Door & 1 False Drawer - 24"W x 34-1/2"H x 24"D	36 1/4	26 1/4	4 1/4	2.27	48.94	
	SB30	Sink Base - 2 Door & 1 False Drawer - 30"W x 34-1/2"H x 24"D	36 1/4	32	4 1/4	2.78	54.67	
	SB33	Sink Base - 2 Door & 1 False Drawer - 33"W x 34-1/2"H x 24"D	36 1/4	32	4 1/4	2.78	58.42	
	SB36	Sink Base - 2 Door & 1 False Drawer - 36"W x 34-1/2"H x 24"D	37 3/4	32	4 1/4	2.90	63.71	
SINK BASE CABINET		ITEM	Description	L (in.)	W (in.)	H (in.)	Cubic Feet (ft <sup>3</sup> ) /CTN	Ib/CTN
	SB39	Sink Base - 2 Door & 2 False Drawer - 39"W x 34-1/2"H x 24"D	40 3/4	32	4 1/4	3.13	65.48	
	SB42	Sink Base - 2 Door & 2 False Drawer - 42"W x 34-1/2"H x 24"D	43 3/4	32	4 1/4	3.35	68.89	
FARM SINK BASE CABINET		ITEM	Description	L (in.)	W (in.)	H (in.)	Cubic Feet (ft <sup>3</sup> ) /CTN	Ib/CTN
	FS36	Sink Base - Farmhouse w/ 2 Door - 36"W x 34-1/2"H x 24"D	37 3/4	32 1/4	5	3.60	69.23	

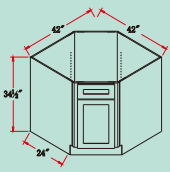
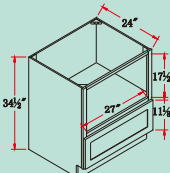
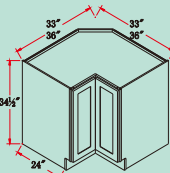
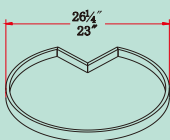
DIAGONAL SINK BASE		ITEM	Description	L (in.)	W (in.)	H (in.)	Cubic Feet (ft <sup>3</sup> ) /CTN	Ib/CTN
	DSB36	Corner Sink Base - Diagonal w/ 1 Door & 1 False Drawer - 36"W x 34-1/2"H x 24"D	37	37 1/2	5 3/4	4.60	129.96	
	DSB42	Corner Sink Base - Diagonal w/ 1 Door & 1 False Drawer - 42"W x 34-1/2"H x 24"D	43 1/2	44	4 3/4	5.22	157.63	
BASE MICROWAVE CABINET		ITEM	Description	L (in.)	W (in.)	H (in.)	Cubic Feet (ft <sup>3</sup> ) /CTN	Ib/CTN
	BMC30	Appliance Base - Microwave Shelf w/ 1 Drawer - 30"W x 34-1/2"H x 24"D	36 1/4	32	5	3.44	78.15	
LAZY SUSAN BASE CORNER CABINET		ITEM	Description	L (in.)	W (in.)	H (in.)	Cubic Feet (ft <sup>3</sup> ) /CTN	Ib/CTN
	LSB33	Corner Base - Lazy Susan w/ 2 Door - 33"W x 34-1/2"H	36 1/4	34 3/4	5	3.74	80.36	
	LSB36	Corner Base - Lazy Susan w/ 2 Door - 36"W x 34-1/2"H	37 1/2	38	5	4.23	86.75	
	LST33	Lazy Susan 33" Wood Basket (w/ Turntable)	24 1/2	25	7 3/4	2.80	19.40	
	LST36	Lazy Susan 36" Wood Basket (w/ Turntable)	27 3/4	28 1/4	7 3/4	3.56	22.27	

BLIND BASE CORNER CABINET	ITEM	Description	L (in.)	W (in.)	H (in.)	Cubic Feet (ft <sup>3</sup> ) /CTN	lb/CTN
	BBC39/42	Blind Base Corner- Blind w/ 1 Door & 1 Drawer - 39"W x 34-1/2"H x 24"D	40 3/4	32	4 3/4	3.57	84.66
	BBC42/45	Blind Base Corner- Blind w/ 1 Door & 1 Drawer - 42"W x 34-1/2"H x 24"D	43 3/4	32	4 3/4	3.83	86.86
24" DEEP FULL DOOR BASE	ITEM	Description	L (in.)	W (in.)	H (in.)	Cubic Feet (ft <sup>3</sup> ) /CTN	lb/CTN
	BF09-PO	Pull Out Base - Spice Rack w/ Drawer - 09"W x 34-1/2"H x 24"D	37 1/4	27 3/4	9 3/4	5.88	53.79
BASE END SHELF CABINET	ITEM	Description	L (in.)	W (in.)	H (in.)	Cubic Feet (ft <sup>3</sup> ) /CTN	lb/CTN
	BES12L	Base End Shelf- End Shelf w/ 4 Shelf (Left Open) - 12"W x 34-1/2"H x 24"D	36 1/4	26 1/4	3 1/4	1.84	38.58
	BES12R	Base End Shelf- End Shelf w/ 4 Shelf (Right Open) - 12"W x 34-1/2"H x 24"D	36 1/4	26 1/4	3 1/4	1.84	38.58
BASE END CORNER	ITEM	Description	L (in.)	W (in.)	H (in.)	Cubic Feet (ft <sup>3</sup> ) /CTN	lb/CTN
	BEC24	Base End Corner- Angle End w/ 2 Full Height Door - 24"W x 34-1/2"H x 24"D	36 1/4	32 1/4	4 3/4	3.19	47.40

BASE WASTE BASKET CABINET	ITEM	Description	L (in.)	W (in.)	H (in.)	Cubic Feet (ft <sup>3</sup> ) /CTN	lb/CTN
	B18TR	Pull Out Base - Trash Pull Out (incl. 2 Basket) w/ 1 Drawer - 18"W x 34-1/2"H x 24"D	36 1/4	25 1/2	5 1/2	2.96	72.64
Waste Basket included							
24" DEEP FULL DOOR BASE CABINET	ITEM	Description	L (in.)	W (in.)	H (in.)	Cubic Feet (ft <sup>3</sup> ) /CTN	lb/CTN
	BF1224	Full Height Base - 1 Door & 1 Shelf - 12"W x 34-1/2"H x 24"D	36 1/4	25 1/2	4 1/4	2.32	38.69
	BF1524	Full Height Base - 1 Door & 1 Shelf - 15"W x 34-1/2"H x 24"D	36 1/4	25 1/2	4 1/4	2.32	42.77
	BF1824	Full Height Base - 1 Door & 1 Shelf - 18"W x 34-1/2"H x 24"D	36 1/4	25 1/2	4 1/4	2.32	45.75
	BF2124	Full Height Base - 1 Door & 1 Shelf - 21"W x 34-1/2"H x 24"D	36 1/4	25 1/2	4 1/4	2.32	48.83
24" DEEP FULL DOOR BASE CABINET	ITEM	Description	L (in.)	W (in.)	H (in.)	Cubic Feet (ft <sup>3</sup> ) /CTN	lb/CTN
	BF2424	Full Height Base - 2 Door & 1 Shelf - 24"W x 34-1/2"H x 24"D	36 1/4	25 1/2	4 1/4	2.32	54.78
	BF2724	Full Height Base - 2 Door & 1 Shelf - 27"W x 34-1/2"H x 24"D	36 1/4	28 1/4	4 1/4	2.56	57.43
	BF3024	Full Height Base - 2 Door & 1 Shelf - 30"W x 34-1/2"H x 24"D	36 1/4	32	4 1/4	2.91	61.51
	BF3324	Full Height Base - 2 Door & 1 Shelf - 33"W x 34-1/2"H x 24"D	36 1/4	32	4 1/4	2.91	65.15
	BF3624	Full Height Base - 2 Door & 1 Shelf - 36"W x 34-1/2"H x 24"D	37 3/4	32	4 1/4	3.04	68.23
30" HIGH 12" DEEP WALL CABINET	ITEM	Description	L (in.)	W (in.)	H (in.)	Cubic Feet (ft <sup>3</sup> ) /CTN	lb/CTN
	W0930	Standard Wall - 1 Door & 2 Shelf - 09"W x 30"H x 12"D	31 3/4	14 1/4	4 3/4	1.23	21.61
	W1230	Standard Wall - 1 Door & 2 Shelf - 12"W x 30"H x 12"D	31 3/4	14 1/4	4 3/4	1.23	24.91
	W1530	Standard Wall - 1 Door & 2 Shelf - 15"W x 30"H x 12"D	31 3/4	17 1/4	4 3/4	1.48	28.33
	W1830	Standard Wall - 1 Door & 2 Shelf - 18"W x 30"H x 12"D	31 3/4	20 1/4	4 3/4	1.76	32.74
	W2130	Standard Wall - 1 Door & 2 Shelf - 21"W x 30"H x 12"D	31 3/4	23 1/4	4 3/4	2.01	34.83

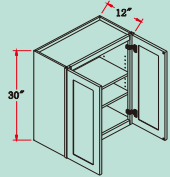
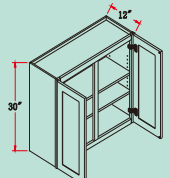
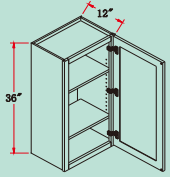
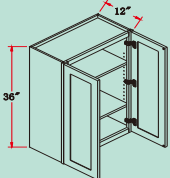
30" HIGH 12" DEEP WALL CABINET	ITEM	Description	L (in.)	W (in.)	H (in.)	Cubic Feet (ft <sup>3</sup> ) /CTN	lb/CTN
	W2430	Standard Wall - 2 Door & 2 Shelf - 24"W x 30"H x 12"D	31 3/4	26 1/4	4 1/4	2.08	41.23
	W2730	Standard Wall - 2 Door & 2 Shelf - 27"W x 30"H x 12"D	31 3/4	29 1/4	4 1/4	2.31	44.42
	W3030	Standard Wall - 2 Door & 2 Shelf - 30"W x 30"H x 12"D	31 3/4	32	4 1/4	2.55	48.06
	W3330	Standard Wall - 2 Door & 2 Shelf - 33"W x 30"H x 12"D	34 3/4	32	4 1/4	2.80	52.25
	W3630	Standard Wall - 2 Door & 2 Shelf - 36"W x 30"H x 12"D	37 3/4	32	4 1/4	3.04	56.88
30" HIGH 12" DEEP WALL CABINET	ITEM	Description	L (in.)	W (in.)	H (in.)	Cubic Feet (ft <sup>3</sup> ) /CTN	lb/CTN
	W3930	Standard Wall - 2 Door & 2 Shelf - 39"W x 30"H x 12"D	40 3/4	32	4 1/4	3.28	60.08
	W4230	Standard Wall - 2 Door & 2 Shelf - 42"W x 30"H x 12"D	43 3/4	32	4 1/4	3.51	65.81
36" HIGH 12" DEEP WALL CABINET	ITEM	Description	L (in.)	W (in.)	H (in.)	Cubic Feet (ft <sup>3</sup> ) /CTN	lb/CTN
	W0936	Standard Wall - 1 Door & 2 Shelf - 09"W x 36"H x 12"D	37 3/4	14 1/4	4 3/4	1.46	25.24
	W1236	Standard Wall - 1 Door & 2 Shelf - 12"W x 36"H x 12"D	37 3/4	14 1/4	4 3/4	1.46	28.66
	W1536	Standard Wall - 1 Door & 2 Shelf - 15"W x 36"H x 12"D	37 3/4	17 1/4	4 3/4	1.77	33.29
	W1836	Standard Wall - 1 Door & 2 Shelf - 18"W x 36"H x 12"D	37 3/4	20 1/4	4 3/4	2.10	37.26
	W2136	Standard Wall - 1 Door & 2 Shelf - 21"W x 36"H x 12"D	37 3/4	23 1/4	4 3/4	2.40	41.34
36" HIGH 12" DEEP WALL CABINET	ITEM	Description	L (in.)	W (in.)	H (in.)	Cubic Feet (ft <sup>3</sup> ) /CTN	lb/CTN
	W2436	Standard Wall - 2 Door & 2 Shelf - 24"W x 36"H x 12"D	37 3/4	26 1/4	4 1/4	2.48	48.39
	W2736	Standard Wall - 2 Door & 2 Shelf - 27"W x 36"H x 12"D	37 3/4	29 1/4	4 1/4	2.76	53.35
	W3036	Standard Wall - 2 Door & 2 Shelf - 30"W x 36"H x 12"D	37 3/4	32	4 1/4	3.04	55.78
	W3336	Standard Wall - 2 Door & 2 Shelf - 33"W x 36"H x 12"D	37 3/4	35 1/4	4 1/4	3.34	59.86
	W3636	Standard Wall - 2 Door & 2 Shelf - 36"W x 36"H x 12"D	37 3/4	38 1/4	4 1/4	3.62	61.51

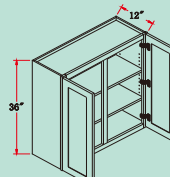
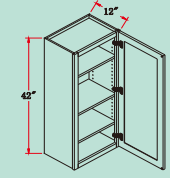
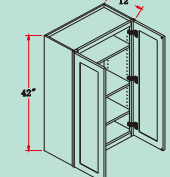
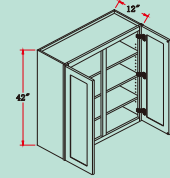
36" HIGH 12" DEEP WALL CABINET	ITEM	Description	L (in.)	W (in.)	H (in.)	Cubic Feet (ft <sup>3</sup> ) /CTN	lb/CTN
	W3936	Standard Wall - 2 Door & 2 Shelf - 39"W x 36"H x 12"D	40 3/4	38 1/4	4 1/4	3.90	65.04
	W4236	Standard Wall - 2 Door & 2 Shelf - 42"W x 36"H x 12"D	43 3/4	38 1/4	4 1/4	4.18	75.62
42" HIGH 12" DEEP WALL CABINET	ITEM	Description	L (in.)	W (in.)	H (in.)	Cubic Feet (ft <sup>3</sup> ) /CTN	lb/CTN
	W0942	Standard Wall - 1 Door & 3 Shelf - 09"W x 42"H x 12"D	43 3/4	14 1/4	4 3/4	1.69	29.76
	W1242	Standard Wall - 1 Door & 3 Shelf - 12"W x 42"H x 12"D	43 3/4	14 1/4	4 3/4	1.69	33.29
	W1542	Standard Wall - 1 Door & 3 Shelf - 15"W x 42"H x 12"D	43 3/4	17 1/4	4 3/4	2.05	38.69
	W1842	Standard Wall - 1 Door & 3 Shelf - 18"W x 42"H x 12"D	43 3/4	20 1/4	4 3/4	2.42	44.53
	W2142	Standard Wall - 1 Door & 3 Shelf - 21"W x 42"H x 12"D	43 3/4	23 1/4	4 3/4	2.78	46.19
42" HIGH 12" DEEP WALL CABINET	ITEM	Description	L (in.)	W (in.)	H (in.)	Cubic Feet (ft <sup>3</sup> ) /CTN	lb/CTN
	W2442	Standard Wall - 2 Door & 2 Shelf - 24"W x 42"H x 12"D	43 3/4	26 1/4	4 1/4	2.87	54.90
	W2742	Standard Wall - 2 Door & 2 Shelf - 27"W x 42"H x 12"D	43 3/4	29 1/4	4 1/4	3.19	59.86
	W3042	Standard Wall - 2 Door & 2 Shelf - 30"W x 42"H x 12"D	43 3/4	32	4 1/4	3.51	65.15
	W3342	Standard Wall - 2 Door & 2 Shelf - 33"W x 42"H x 12"D	43 3/4	35 1/4	4 1/4	3.86	71.32
	W3642	Standard Wall - 2 Door & 2 Shelf - 36"W x 42"H x 12"D	43 3/4	38 1/4	4 1/4	4.18	74.54
42" HIGH 12" DEEP WALL CABINET	ITEM	Description	L (in.)	W (in.)	H (in.)	Cubic Feet (ft <sup>3</sup> ) /CTN	lb/CTN
	W3942	Standard Wall - 2 Door & 2 Shelf - 39"W x 42"H x 12"D	43 3/4	41 1/4	4 1/4	4.51	80.80
	W4242	Standard Wall - 2 Door & 2 Shelf - 42"W x 42"H x 12"D	43 3/4	44	4 1/4	4.83	87.08

WALL DIAGONAL CORNER CABINET	ITEM	Description	L (in.)	W (in.)	H (in.)	Cubic Feet (ft <sup>3</sup> ) /CTN	Ib/CTN
	WDC2430	Corner Wall - Diagonal w/ 1 Door & 2 Shelf - 24"W x 30"H x 12"D	31 3/4	25 3/4	6	2.79	54.90
	WDC2436	Corner Wall - Diagonal w/ 1 Door & 2 Shelf - 24"W x 36"H x 12"D	37 3/4	25 3/4	6 3/4	3.77	65.04
	WDC2442	Corner Wall - Diagonal w/ 1 Door & 3 Shelf - 24"W x 42"H x 12"D	43 3/4	25 3/4	6	3.85	72.09
WALL PIE CUT CORNER CABINET	ITEM	Description	L (in.)	W (in.)	H (in.)	Cubic Feet (ft <sup>3</sup> ) /CTN	Ib/CTN
	WPC2430	Corner Wall - Pie-cut w/ 1 Door & 2 Shelf - 24"W x 30"H x 12"D	35 1/2	27	4	2.18	52.03
	WPC2436	Corner Wall - Pie-cut w/ 1 Door & 2 Shelf - 24"W x 36"H x 12"D	37 3/4	27	4 1/2	2.67	60.19
	WPC2442	Corner Wall - Pie-cut w/ 1 Door & 3 Shelf - 24"W x 42"H x 12"D	44	27	4 1/2	3.10	73.30
WALL BLIND CORNER	ITEM	Description	L (in.)	W (in.)	H (in.)	Cubic Feet (ft <sup>3</sup> ) /CTN	Ib/CTN
	WBC2730	Corner Wall - Blind w/ 1 Door & 2 Shelf - 27"W x 30"H x 12"D	31 3/4	29 1/4	4 1/4	2.31	45.19
	WBC2736	Corner Wall - Blind w/ 1 Door & 2 Shelf - 27"W x 36"H x 12"D	37 3/4	29 1/4	4 1/4	2.76	50.71
	WBC2742	Corner Wall - Blind w/ 1 Door & 3 Shelf - 27"W x 42"H x 12"D	43 3/4	29 1/4	4 1/4	3.19	61.29
WALL MICROWAVE	ITEM	Description	L (in.)	W (in.)	H (in.)	Cubic Feet (ft <sup>3</sup> ) /CTN	Ib/CTN
	WM3030	Appliance Wall - Microwave Shelf w/ 2 Door - 30"W x 30"H x 12"D	31 3/4	32	4 1/4	2.55	45.19
	WM3036	Appliance Wall - Microwave Shelf w/ 2 Door - 30"W x 36"H x 12"D	37 1/2	32	4 1/4	3.02	48.50
	WM3042	Appliance Wall - Microwave Shelf w/ 2 Door & 1 Shelf - 30"W x 42"H x 12"D	43 3/4	32	4 1/4	3.51	60.30

WALL END SHELF	ITEM	Description	L (in.)	W (in.)	H (in.)	Cubic Feet (ft <sup>3</sup> ) /CTN	Ib/CTN
	OE1230	Corner Wall - End Shelf w/ 4 Shelf - 12"W x 30"H x 12"D	31 3/4	14 1/4	3 1/2	0.92	22.60
	OE1236	Corner Wall - End Shelf w/ 4 Shelf - 12"W x 36"H x 12"D	37 3/4	14 1/4	3 1/2	1.10	25.02
	OE1242	Corner Wall - End Shelf w/ 5 Shelf - 12"W x 42"H x 12"D	43 3/4	14 1/4	3 1/2	1.27	27.89
WALL ANGLE END CABINET	ITEM	Description	L (in.)	W (in.)	H (in.)	Cubic Feet (ft <sup>3</sup> ) /CTN	Ib/CTN
	WAE1230	Corner Wall - Angle End w/ 1 Door & 2 Shelf - 12"W x 30"H x 12"D	32	19 1/2	4	1.42	18.96
	WAE1236	Corner Wall - Angle End w/ 1 Door & 2 Shelf - 12"W x 36"H x 12"D	38	19 1/2	4	1.69	22.93
	WAE1242	Corner Wall - Angle End w/ 1 Door & 3 Shelf - 12"W x 42"H x 12"D	44 1/4	19 1/2	4	1.97	25.04
WALL WITH DRAWERS CABINET	ITEM	Description	L (in.)	W (in.)	H (in.)	Cubic Feet (ft <sup>3</sup> ) /CTN	Ib/CTN
	WD1848	Drawer Wall - 1 Door & 2 Drawer - 18"W x 48"H x 15"D	49 3/4	20 1/2	4 3/4	2.80	77.16
	WD1854	Drawer Wall - 1 Door & 2 Drawer - 18"W x 54"H x 15"D	55 3/4	20 1/2	5	3.40	85.98
	WD1860	Drawer Wall - 1 Door & 2 Drawer - 18"W x 60"H x 15"D	62 1/2	20 1/2	5	3.81	93.70
12" HIGH 12" DEEP WALL BRIDGE CABINET	ITEM	Description	L (in.)	W (in.)	H (in.)	Cubic Feet (ft <sup>3</sup> ) /CTN	Ib/CTN
	W3012	Standard Wall - 2 Door - 30"W x 12"H x 12"D	32 3/4	14 3/4	4 1/4	1.16	22.82
	W3312	Standard Wall - 2 Door - 33"W x 12"H x 12"D	35 1/4	14 3/4	4 1/4	1.24	23.92
	W3612	Standard Wall - 2 Door - 36"W x 12"H x 12"D	38	14 3/4	4 1/4	1.34	26.01
	W3912	Standard Wall - 2 Door - 39"W x 12"H x 12"D	41 1/4	14 1/4	4 1/4	1.39	27.89

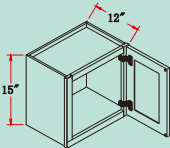
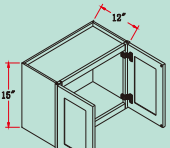
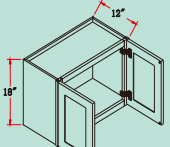
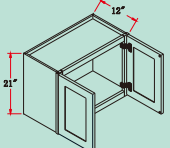
15" HIGH 12" DEEP WALL BRIDGE CABINET	ITEM	Description	L (in.)	W (in.)	H (in.)	Cubic Feet (ft <sup>3</sup> ) /CTN	lb/CTN
	W1215	Standard Wall - 1 Door - 12"W x 15"H x 12"D	17 1/4	14 3/4	4 3/4	0.69	12.90
	W1515	Standard Wall - 1 Door - 15"W x 15"H x 12"D	17 1/4	17 1/2	4 3/4	0.82	15.43
	W1815	Standard Wall - 1 Door - 18"W x 15"H x 12"D	20	17 1/2	4 3/4	0.95	17.31
	W2115	Standard Wall - 1 Door - 21"W x 15"H x 12"D	22 3/4	17 1/2	6 3/4	1.55	20.28
	W2415	Standard Wall - 2 Door - 24"W x 15"H x 12"D	25 3/4	17 1/2	4 1/4	1.08	22.49
	W2715	Standard Wall - 2 Door - 27"W x 15"H x 12"D	29	17 1/2	4 1/4	1.21	24.03
	W3015	Standard Wall - 2 Door - 30"W x 15"H x 12"D	31 3/4	17 1/2	4 1/4	1.33	24.91
	W3315	Standard Wall - 2 Door - 33"W x 15"H x 12"D	35 1/4	17 1/2	4 1/4	1.48	27.12
	W3615	Standard Wall - 2 Door - 36"W x 15"H x 12"D	38	17 1/2	4 1/4	1.59	30.31
	W3915	Standard Wall - 2 Door - 39"W x 15"H x 12"D	41 1/4	17 1/4	4 1/4	1.69	31.64
	W2418	Standard Wall - 2 Door - 24"W x 18"H x 12"D	25 3/4	20 1/4	4 1/4	1.25	24.69
	W3018	Standard Wall - 2 Door - 30"W x 18"H x 12"D	32	20 1/4	4 1/4	1.56	28.88
	W3318	Standard Wall - 2 Door - 33"W x 18"H x 12"D	35 1/4	20 1/4	4 1/4	1.71	30.53
	W3618	Standard Wall - 2 Door - 36"W x 18"H x 12"D	38	20 1/4	4 1/4	1.84	33.40
	W3918	Standard Wall - 2 Door - 39"W x 18"H x 12"D	41 1/4	20 1/4	4 1/4	2.00	36.16
		W3021	Standard Wall - 2 Door - 30"W x 21"H x 12"D	31 3/4	23 1/2	4 1/4	1.78
W3321		Standard Wall - 2 Door - 33"W x 21"H x 12"D	35 1/4	23 1/2	4 1/4	1.97	38.36
W3621		Standard Wall - 2 Door - 36"W x 21"H x 12"D	38	23 1/2	4 1/2	2.33	41.34
W3921		Standard Wall - 2 Door - 39"W x 21"H x 12"D	41 1/4	23 1/2	4 1/2	2.53	47.95

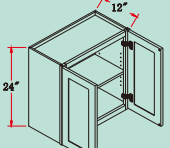
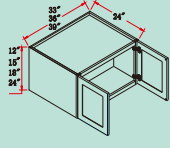
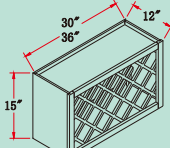
24" HIGH 12" DEEP WALL BRIDGE CABINET	ITEM	Description	L (in.)	W (in.)	H (in.)	Cubic Feet (ft <sup>3</sup> ) /CTN	lb/CTN
	W2424	Standard Wall - 2 Door & 1 Shelf - 24"W x 24"H x 12"D	25 3/4	26 1/4	4 1/2	1.77	33.18
	W3024	Standard Wall - 2 Door & 1 Shelf - 30"W x 24"H x 12"D	31 3/4	26 1/4	4 1/2	2.17	39.46
	W3324	Standard Wall - 2 Door & 1 Shelf - 33"W x 24"H x 12"D	35 1/4	26 1/4	4 1/2	2.42	43.54
	W3624	Standard Wall - 2 Door & 1 Shelf - 36"W x 24"H x 12"D	38	26 1/4	4 1/2	2.61	44.42
	W3924	Standard Wall - 2 Door & 1 Shelf - 39"W x 24"H x 12"D	41 1/4	26 1/4	4 1/2	2.82	49.27
	W331224	Standard Wall - 2 Door - 33"W x 12"H x 24"D	34 3/4	26 1/4	4 1/4	2.29	33.07
	W331524	Standard Wall - 2 Door - 33"W x 15"H x 24"D	34 3/4	26 1/4	4 1/4	2.29	37.48
	W331824	Standard Wall - 2 Door - 33"W x 18"H x 24"D	34 3/4	26 1/4	4 1/4	2.29	42.00
	W332424	Standard Wall - 2 Door & 1 Shelf - 33"W x 24"H x 24"D	34 3/4	26 1/4	5 3/4	3.01	57.32
	W361224	Standard Wall - 2 Door - 36"W x 12"H x 24"D	38	26 1/4	4 1/4	2.49	39.57
	W361524	Standard Wall - 2 Door - 36"W x 15"H x 24"D	38	26 1/4	4 1/4	2.49	43.87
	W361824	Standard Wall - 2 Door - 36"W x 18"H x 24"D	38	26 1/4	4 1/4	2.49	48.61
	W362124	Standard Wall - 2 Door & 1 Shelf - 36"W x 21"H x 24"D	38	26 1/4	5 1/2	3.17	43.87
	W362424	Standard Wall - 2 Door & 1 Shelf - 36"W x 24"H x 24"D	38	26 1/4	5 3/4	3.29	64.60
	W391224	Standard Wall - 2 Door - 39"W x 12"H x 24"D	41 1/4	26 1/4	4 1/4	2.70	42.99
	W391524	Standard Wall - 2 Door - 39"W x 15"H x 24"D	41 1/4	26 1/4	4 1/4	2.70	47.40
	W391824	Standard Wall - 2 Door - 39"W x 18"H x 24"D	41 1/4	26 1/4	4 1/4	2.70	50.71
	W392424	Standard Wall - 2 Door & 1 Shelf - 39"W x 24"H x 24"D	41 1/4	26 1/4	5 3/4	3.56	70.77
		WR3015	Wall - Wine Rack - 30"W x 15"H x 12"D	31 3/4	17 1/4	5	1.61
WR3615		Wall - Wine Rack - 36"W x 15"H x 12"D	37 3/4	17 1/4	5	1.92	31.97

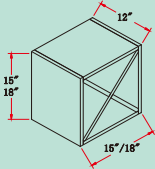
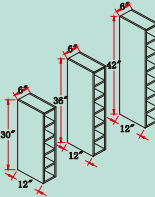
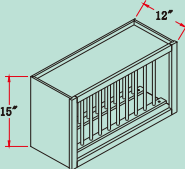
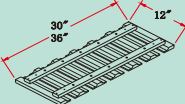
WINE RACK	ITEM	Description	L (in.)	W (in.)	H (in.)	Cubic Feet (ft <sup>3</sup> ) /CTN	lb/CTN
	WR1515	Wall - Wine Rack - Incl. Shelf - 15"W x 15"H x 12"D	20 3/4	16 1/4	5 1/2	1.08	26.68
	WR1818	Wall - Wine Rack - Incl. Shelf - 18"W x 18"H x 12"D	25 1/4	18 3/4	5 1/2	1.50	32.63
WINE CUBE	ITEM	Description	L (in.)	W (in.)	H (in.)	Cubic Feet (ft <sup>3</sup> ) /CTN	lb/CTN
	WC0630	Wall - Wine Cube - 06"W x 30"H x 12"D	32	14 1/2	3	0.80	20.50
	WC0636	Wall - Wine Cube - 06"W x 36"H x 12"D	38	14 1/2	3	0.95	23.92
	WC0642	Wall - Wine Cube - 06"W x 42"H x 12"D	43 3/4	14 1/2	3	1.09	26.46
PLATE RACK	ITEM	Description	L (in.)	W (in.)	H (in.)	Cubic Feet (ft <sup>3</sup> ) /CTN	lb/CTN
	PR3015	Wall - Plate Rack - 30"W x 15"H x 12"D	31 3/4	17 1/4	6 3/4	2.10	24.03
GLASS HOLDER	ITEM	Description	L (in.)	W (in.)	H (in.)	Cubic Feet (ft <sup>3</sup> ) /CTN	lb/CTN
	GL30	Wall - Glass Holder - 30"W x 1-1/2"H x 12"D	31 1/4	14 1/4	2	0.51	5.84
	GL36	Wall - Glass Holder - 36"W x 1-1/2"H x 12"D	37 1/2	14 1/4	2	0.60	7.05

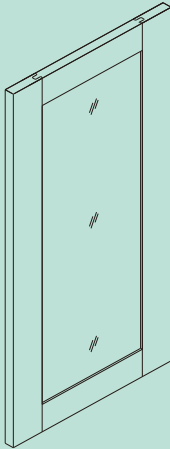

GLASS DOOR	ITEM	Description	L (in.)	W (in.)	H (in.)	Cubic Feet (ft <sup>3</sup> ) /CTN	lb/CTN
	GDW1230	Glass Door - 12"W x 30"H	31 1/4	13 3/4	1 1/2	0.34	7.61
	GDW1530	Glass Door - 15"W x 30"H	31 1/4	16 3/4	1 1/2	0.42	9.26
	GDW1830	Glass Door - 18"W x 30"H	31 1/4	19 3/4	1 1/2	0.49	11.46
	GDW2130	Glass Door - 21"W x 30"H	31 1/4	22 3/4	1 1/2	0.57	13.01
	GDW2430	Glass Door - 24"W x 30"H	31 1/4	25 3/4	2 1/4	0.57	14.33
	GDW2730	Glass Door - 27"W x 30"H	31 1/4	28 3/4	2 1/4	0.64	15.43
	GDW3030	Glass Door - 30"W x 30"H	31 1/4	31	2 1/4	0.70	17.42
	GDW3330	Glass Door - 33"W x 30"H	31 1/4	34 1/4	2 1/4	0.76	19.18
	GDW3630	Glass Door - 36"W x 30"H	31 1/4	37	2 1/4	0.82	22.49
	GDWDC2430	Glass Door - WDC2430	31 1/4	16	1 1/2	0.40	18.08
	GDW1236	Glass Door - 12"W x 36"H	37 1/4	13 3/4	1 1/2	0.41	8.82
	GDW1536	Glass Door - 15"W x 36"H	37 1/4	16 3/4	1 1/2	0.50	10.58
	GDW1836	Glass Door - 18"W x 36"H	37 1/4	19 3/4	1 1/2	0.58	12.79
	GDW2136	Glass Door - 21"W x 36"H	37 1/4	22 3/4	1 1/2	0.67	14.33
	GDW2436	Glass Door - 24"W x 36"H	37 1/4	25 3/4	2 1/4	0.68	15.65
	GDW2736	Glass Door - 27"W x 36"H	37 1/4	28 3/4	2 1/4	0.76	18.30
	GDW3036	Glass Door - 30"W x 36"H	37 1/4	31	2 1/4	0.83	20.28
	GDW3336	Glass Door - 33"W x 36"H	37 1/4	34 1/4	2 1/4	0.90	22.05
	GDW3636	Glass Door - 36"W x 36"H	37 1/4	37	2 1/4	0.98	25.57
	GDWDC2436	Glass Door - WDC2436	37 1/4	16	1 1/2	0.47	21.16
	GDW1242	Glass Door - 12"W x 42"H	43 1/4	13 3/4	1 1/2	0.48	9.92
	GDW1542	Glass Door - 15"W x 42"H	43 1/4	16 3/4	1 1/2	0.58	11.90
	GDW1842	Glass Door - 18"W x 42"H	43 1/4	19 3/4	1 1/2	0.68	14.77
	GDW2142	Glass Door - 21"W x 42"H	43 1/4	22 3/4	1 1/2	0.78	17.64
	GDW2442	Glass Door - 24"W x 42"H	43 1/4	25 3/4	2 1/4	0.79	20.28
	GDW2742	Glass Door - 27"W x 42"H	43 1/4	28 3/4	2 1/4	0.88	21.38
	GDW3042	Glass Door - 30"W x 42"H	43 1/4	31	2 1/4	0.97	23.59
	GDW3342	Glass Door - 33"W x 42"H	43 1/4	34 1/4	2 1/4	1.05	25.90
	GDW3642	Glass Door - 36"W x 42"H	43 1/4	37	2 1/4	1.14	28.44
	GDWDC2442	Glass Door - WDC2442	43 1/4	16	1 1/2	0.55	23.81
	GDW1215	Glass Door - 12"W x 15"H	16 1/4	13 3/4	1 1/2	0.18	1.98
	GDW1515	Glass Door - 15"W x 15"H	16 1/4	16 3/4	1 1/2	0.22	3.75
	GDW1815	Glass Door - 18"W x 15"H	19 1/4	16 3/4	1 1/2	0.26	5.95
	GDW2115	Glass Door - 21"W x 15"H	22 1/4	16 3/4	1 1/2	0.30	7.50
	GDW2415	Glass Door - 24"W x 15"H	16 1/4	19 3/4	2 1/4	0.30	8.82
	GDW2715	Glass Door - 27"W x 15"H	16 1/4	22 3/4	2 1/4	0.33	11.46
	GDW3015	Glass Door - 30"W x 15"H	16 1/2	25 3/4	2 1/4	0.37	13.45
	GDW3315	Glass Door - 33"W x 15"H	18	28 3/4	2 1/4	0.40	15.21
	GDW3615	Glass Door - 36"W x 15"H	19 1/2	31 3/4	2 1/4	0.43	18.74
	GDWDC2415	Glass Door - WDC2415	16 1/4	16	1 1/2	0.21	6.17
	GDW1218	Glass Door - 12"W x 18"H	19 1/4	13 3/4	1 1/2	0.21	3.31
	GDW1518	Glass Door - 15"W x 18"H	19 1/4	16 3/4	1 1/2	0.26	5.29
GDW1818	Glass Door - 18"W x 18"H	19 1/4	19 3/4	1 1/2	0.30	8.16	
GDW2118	Glass Door - 21"W x 18"H	22 1/4	19 3/4	1 1/2	0.35	11.02	
GDW2418	Glass Door - 24"W x 18"H	19 1/4	22 3/4	2 1/4	0.35	13.67	
GDW2718	Glass Door - 27"W x 18"H	19 1/4	25 3/4	2 1/4	0.39	14.77	
GDW3018	Glass Door - 30"W x 18"H	19 1/4	28 3/4	2 1/4	0.43	16.98	
GDW3318	Glass Door - 33"W x 18"H	19 1/4	31 3/4	2 1/4	0.47	19.29	
GDW3618	Glass Door - 36"W x 18"H	19 1/2	34 3/4	2 1/4	0.51	21.83	
GDWDC2418	Glass Door - WDC2418	19 1/4	16	1 1/2	0.25	8.82	

FLLOATING SHELF	ITEM	Description	L (in.)	W (in.)	H (in.)	Cubic Feet (ft <sup>3</sup> ) /CTN	Ib/CTN
	FLS30	Flat Shelf 30"W x 2"H x 12"D	31 1/2	14	2 3/4	0.70	10.25
	FLS36	Flat Shelf 36"W x 2"H x 12"D	37 1/4	14	2 3/4	0.83	12.35
	FLS48	Flat Shelf 48"W x 2"H x 12"D	49 1/2	14	2 3/4	1.10	14.99
WOOD HOOD	ITEM	Description	L (in.)	W (in.)	H (in.)	Cubic Feet (ft <sup>3</sup> ) /CTN	Ib/CTN
	RHA3030	Wall - Wood Range Hood - 30"W x 30"H x 22"D					
	RHA3630	Wall - Wood Range Hood - 36"W x 30"H x 22"D					
	RHA4230	Wall - Wood Range Hood - 42"W x 30"H x 22"D					
	RHA4236	Wall - Wood Range Hood - 42"W x 36"H x 22"D					
PANTRY CABINETS 24" DEEP	ITEM	Description	L (in.)	W (in.)	H (in.)	Cubic Feet (ft <sup>3</sup> ) /CTN	Ib/CTN
	TP1894	Tall - Shelf Pantry w/ 2 Door & 5 Shelf - 18"W x 84"H x 24"D	86	26 1/4	5	6.41	116.29
	TP1890	Tall - Shelf Pantry w/ 2 Door & 5 Shelf - 18"W x 90"H x 24"D	92	26 1/4	5	6.85	124.34
	TP1896	Tall - Shelf Pantry w/ 2 Door & 6 Shelf - 18"W x 96"H x 24"D	97 3/4	26 1/4	5	7.29	135.25
PANTRY CABINETS 24" DEEP	ITEM	Description	L (in.)	W (in.)	H (in.)	Cubic Feet (ft <sup>3</sup> ) /CTN	Ib/CTN
	TP2484	Tall - Shelf Pantry w/ 4 Door & 5 Shelf - 24"W x 84"H x 24"D	86	26 1/4	5	6.41	142.20
	TP2490	Tall - Shelf Pantry w/ 4 Door & 5 Shelf - 24"W x 90"H x 24"D	92	26 1/4	5	6.85	157.52
	TP2496	Tall - Shelf Pantry w/ 4 Door & 6 Shelf - 24"W x 96"H x 24"D	97 3/4	26 1/4	5	7.29	167.77
	TP3084	Tall - Shelf Pantry w/ 4 Door & 5 Shelf - 30"W x 84"H x 24"D	86	32 1/2	5	7.96	168.21
	TP3090	Tall - Shelf Pantry w/ 4 Door & 5 Shelf - 30"W x 90"H x 24"D	92	32 1/2	5	8.50	181.00
	TP3096	Tall - Shelf Pantry w/ 4 Door & 6 Shelf - 30"W x 96"H x 24"D	97 3/4	32 1/2	5	9.05	194.45

OVEN CABINETS	ITEM	Description	L (in.)	W (in.)	H (in.)	Cubic Feet (ft <sup>3</sup> ) /CTN	Ib/CTN
	OC3394	Appliance Tall - Oven Shelf w/ 2 Door & 3 Drawer - 33"W x 84"H x 24"D	86	35 3/4	5	9.08	206.02
	OC3390	Appliance Tall - Oven Shelf w/ 2 Door & 3 Drawer - 33"W x 90"H x 24"D	92	35 3/4	5	9.70	211.53
	OC3396	Appliance Tall - Oven Shelf w/ 2 Door & 3 Drawer - 33"W x 96"H x 24"D	97 3/4	35 3/4	5	10.32	225.97
VANITY BASE 21" DEEP	ITEM	Description	L (in.)	W (in.)	H (in.)	Cubic Feet (ft <sup>3</sup> ) /CTN	Ib/CTN
	VB1221	Vanity Base - 1 Door & 1 Drawer - 12"W x 34-1/2"H x 21"D	36 1/4	22 1/2	5	2.41	46.08
	VB1521	Vanity Base - 1 Door & 1 Drawer - 15"W x 34-1/2"H x 21"D	36 1/4	22 1/2	5	2.41	49.71
	VB1821	Vanity Base - 1 Door & 1 Drawer - 18"W x 34-1/2"H x 21"D	36 1/4	22 1/2	4	1.85	54.01
	VB2121	Vanity Base - 1 Door & 1 Drawer - 21"W x 34-1/2"H x 21"D	39	22 1/2	4	1.99	57.87
VANITY BASE 21" DEEP	ITEM	Description	L (in.)	W (in.)	H (in.)	Cubic Feet (ft <sup>3</sup> ) /CTN	Ib/CTN
	VB2421	Vanity Base - 2 Door & 1 Drawer - 24"W x 34-1/2"H x 21"D	39	25 1/2	4	2.27	65.26
	VB2721	Vanity Base - 2 Door & 1 Drawer - 27"W x 34-1/2"H x 21"D	39	29	4	2.57	68.78
	VB3021	Vanity Base - 2 Door & 1 Drawer - 30"W x 34-1/2"H x 21"D	39	32	4	2.85	73.74
	VB3321	Vanity Base - 2 Door & 1 Drawer - 33"W x 34-1/2"H x 21"D	36 1/4	32	4	2.65	77.60
	VB3621	Vanity Base - 2 Door & 1 Drawer - 36"W x 34-1/2"H x 21"D	37 3/4	32	4	2.76	82.56
VANITY DRAWERS BASE 21" DEEP	ITEM	Description	L (in.)	W (in.)	H (in.)	Cubic Feet (ft <sup>3</sup> ) /CTN	Ib/CTN
	VDB1221	Vanity Drawer Base - 3 Drawer - 12"W x 34-1/2"H x 21"D	36 1/4	22 1/2	6	2.78	67.68
	VDB1521	Vanity Drawer Base - 3 Drawer - 15"W x 34-1/2"H x 21"D	36 1/4	22 1/2	6 1/4	2.96	72.86
	VDB1821	Vanity Drawer Base - 3 Drawer - 18"W x 34-1/2"H x 21"D	36 1/4	22 1/2	6 1/4	2.96	79.15
	VDB2121	Vanity Drawer Base - 3 Drawer - 21"W x 34-1/2"H x 21"D	37 3/4	26 1/4	6	3.49	84.22
	VDB2421	Vanity Drawer Base - 3 Drawer - 24"W x 34-1/2"H x 21"D	37 3/4	29	6	3.86	92.04
	VDB2721	Vanity Drawer Base - 3 Drawer - 27"W x 34-1/2"H x 21"D	37 3/4	31	6 1/4	4.26	99.32
	VDB3021	Vanity Drawer Base - 3 Drawer - 30"W x 34-1/2"H x 21"D	36 1/4	32	6 1/4	4.24	107.14
VDB3321	Vanity Drawer Base - 3 Drawer - 33"W x 34-1/2"H x 21"D	36 1/4	32	6 1/4	4.24	110.34	
VDB3621	Vanity Drawer Base - 3 Drawer - 36"W x 34-1/2"H x 21"D	37 3/4	32	6 1/4	4.42	117.95	

VANITY SINK BASE 21" DEEP	ITEM	Description	L (in.)	W (in.)	H (in.)	Cubic Feet (ft <sup>3</sup> ) /CTN	Ib/CTN
	VSB2421	Vanity Sink Base - 2 Door & 1 False Drawer - 24"W x 34-1/2"H x 21"D	36 1/4	26	4 1/4	2.36	44.86
	VSB2721	Vanity Sink Base - 2 Door & 1 False Drawer - 27"W x 34-1/2"H x 21"D	36 1/4	29	4 1/4	2.63	48.72
	VSB3021	Vanity Sink Base - 2 Door & 1 False Drawer - 30"W x 34-1/2"H x 21"D	36 1/4	32	4 1/4	2.91	52.14
	VSB3321	Vanity Sink Base - 2 Door & 1 False Drawer - 33"W x 34-1/2"H x 21"D	36 1/4	32	4 1/4	2.91	56.44
	VSB3621	Vanity Sink Base - 2 Door & 1 False Drawer - 36"W x 34-1/2"H x 21"D	37 3/4	32	4 1/4	3.04	58.97
VANITY SINK DRAWER BASE 21" DEEP	ITEM	Description	L (in.)	W (in.)	H (in.)	Cubic Feet (ft <sup>3</sup> ) /CTN	Ib/CTN
	VSD3021L	Vanity Sink Drawer Base - 1 Door & 2 Left Drawer - 30"W x 34-1/2"H x 21"D	36 1/4	32	5	3.44	77.16
	VSD3021R	Vanity Sink Drawer Base - 1 Door & 2 Right Drawer - 30"W x 34-1/2"H x 21"D	36 1/4	32	5	3.44	77.93
VANITY SINK DRAWER BASE 21" DEEP	ITEM	Description	L (in.)	W (in.)	H (in.)	Cubic Feet (ft <sup>3</sup> ) /CTN	Ib/CTN
	VSD3621L	Vanity Sink Drawer Base - 2 Door & 2 Left Drawer - 36"W x 34-1/2"H x 21"D	37 3/4	32	5	3.59	73.19
	VSD3621R	Vanity Sink Drawer Base - 2 Door & 2 Right Drawer - 36"W x 34-1/2"H x 21"D	37 3/4	32	5	3.59	74.08
VANITY SINK DRAWER BASE 21" DEEP	ITEM	Description	L (in.)	W (in.)	H (in.)	Cubic Feet (ft <sup>3</sup> ) /CTN	Ib/CTN
	VSD4221	Vanity Sink Drawer Base - 2 Door, 2 Drawer & False Drawer - 42"W x 34-1/2"H x 21"D	43 3/4	32	5	4.15	85.43

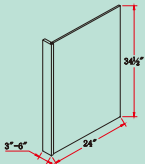
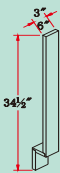
VANITY SINK DRAWER BASE 21" DEEP	ITEM	Description	L (in.)	W (in.)	H (in.)	Cubic Feet (ft <sup>3</sup> ) /CTN	Ib/CTN
	VSD4821	Vanity Sink Drawer Base - 2 Door, 4 Drawer & False Drawer - 48"W x 34-1/2"H x 21"D	50 1/4	32	5	4.77	127.32
VANITY SINK DRAWER SINGLE	ITEM	Description	L (in.)	W (in.)	H (in.)	Cubic Feet (ft <sup>3</sup> ) /CTN	Ib/CTN
	VSD60SINGLE	Vanity Sink Drawer Base - 2 Door, 6 Drawer & False Drawer - 60"W x 34-1/2"H x 21"D	61 3/4	32	5	5.87	166.34
VANITY SINK DRAWER DOUBLE	ITEM	Description	L (in.)	W (in.)	H (in.)	Cubic Feet (ft <sup>3</sup> ) /CTN	Ib/CTN
	VSD60DOUBLE	Vanity Sink Drawer Base - 4 Door, 3 Drawer & 2 False Drawer - 60"W x 34-1/2"H x 21"D	61 3/4	32	5	5.87	126.66
KNEE DRAWER	ITEM	Description	L (in.)	W (in.)	H (in.)	Cubic Feet (ft <sup>3</sup> ) /CTN	Ib/CTN
	KD30	Knee Drawer - 30"W x 7-3/16"H x 21"D	31 3/4	19	2 3/4	0.97	23.26

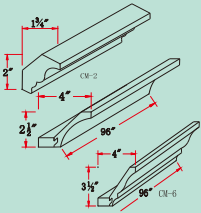
DISHWASHER PANEL	ITEM	Description	L (in.)	W (in.)	H (in.)	Cubic Feet (ft <sup>3</sup> ) /CTN	lb/CTN
	DWR3	Dishwasher Return Panel w/ 3" Filler - 24"W x 34-1/2"H x 1/2"D	35 3/4	25 1/2	1 3/4	0.93	8.80
	DWR6	Dishwasher Return Panel w/ 6" Filler - 24"W x 34-1/2"H x 1/2"D	35 3/4	25 1/2	4 3/4	2.49	9.59
BASE FILLER	ITEM	Description	L (in.)	W (in.)	H (in.)	Cubic Feet (ft <sup>3</sup> ) /CTN	lb/CTN
	BF3	Base Filler 3"-03"W x 34-1/2"H x 3/4"D	38 1/4	8 1/4	3 3/4	0.68	12.13
	BF6	Base Filler 6"-06"W x 34-1/2"H x 3/4"D	38 1/4	8 1/4	6 3/4	1.22	4.29
WALL FILLER	ITEM	Description	L (in.)	W (in.)	H (in.)	Cubic Feet (ft <sup>3</sup> ) /CTN	lb/CTN
	WF330	Wall Filler 3"-03"W x 30"H x 3/4"D	31 1/2	5 3/4	3 1/2	0.37	1.54
	WF336	Wall Filler 3"-03"W x 36"H x 3/4"D	37 1/2	5 3/4	3 1/2	0.44	1.76
	WF342	Wall Filler 3"-03"W x 42"H x 3/4"D	43 1/4	5 3/4	3 1/2	0.51	1.98
	WF396	Wall Filler 3"-03"W x 96"H x 3/4"D	97 1/2	5 3/4	3 1/2	1.14	22.27
	WF630	Wall Filler 6"-06"W x 30"H x 3/4"D	31 1/2	7 3/4	4 1/4	0.62	2.29
	WF636	Wall Filler 6"-06"W x 36"H x 3/4"D	37 1/2	7 3/4	4 1/4	0.74	3.17
	WF642	Wall Filler 6"-06"W x 42"H x 3/4"D	43 1/4	7 3/4	4 1/4	0.85	3.53
	WF696	Wall Filler 6"-06"W x 96"H x 3/4"D	97 1/2	8 1/2	4 3/4	2.28	42.77
CROWN MOLDING	ITEM	Description	L (in.)	W (in.)	H (in.)	Cubic Feet (ft <sup>3</sup> ) /CTN	lb/CTN
	CM2	Crown Molding - 96"W x 2"H x 1-3/4"D					
	CM4	Crown Molding - 96"W x 2-1/2"H x 2-1/2"D	97 1/2	5 3/4	4 1/2	1.46	1.87
	CM6	Crown Molding - 96"W x 3-1/2"H x 2-1/2"D	97 1/2	6	4 1/2	1.56	21.94

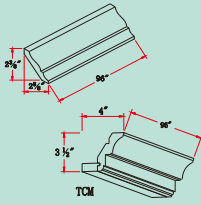
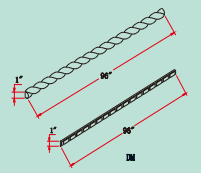
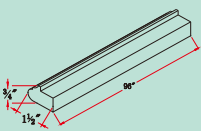
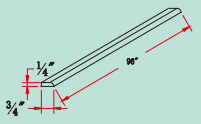

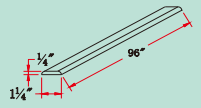
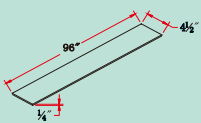
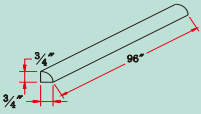
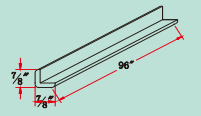
CROWN MOLDING	ITEM	Description	L (in.)	W (in.)	H (in.)	Cubic Feet (ft <sup>3</sup> ) /CTN	lb/CTN
	CM1	Crown Molding - 96"W x 2-5/8"H x 2-3/8"D	97 1/2	5 1/2	4 1/4	1.35	3.33
	TCM	Crown Molding - 96"W x 3-1/2"H x 04"D	97 1/2	7 1/2	6	2.49	7.43
DECORATIVE MOLDING	ITEM	Description	L (in.)	W (in.)	H (in.)	Cubic Feet (ft <sup>3</sup> ) /CTN	lb/CTN
	RM	Rope Molding - 96"W x 01"H x 3/8"D					0.49
	DM	Dentil Molding - 96"W x 01"H x 3/8"D					0.46
LIGHT RAIL MOLDING	ITEM	Description	L (in.)	W (in.)	H (in.)	Cubic Feet (ft <sup>3</sup> ) /CTN	lb/CTN
	LRM	Light Rail Molding - 96"W x 1-1/2"H x 3/4"D	97 1/2	6 3/4	2 1/4	0.82	0.85
SCRIBE MOLDING	ITEM	Description	L (in.)	W (in.)	H (in.)	Cubic Feet (ft <sup>3</sup> ) /CTN	lb/CTN
	SMR-S	Scribe Molding - 96"W x 3/4"H x 1/4"D	97 1/2	5 3/4	2 1/4	0.70	9.26

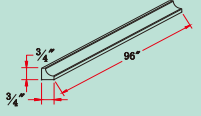
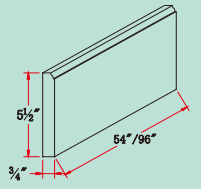
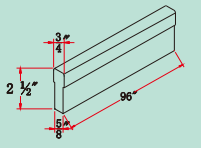
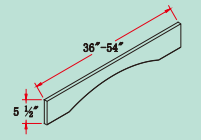
BATTEN MOLDING	ITEM	Description	L (in.)	W (in.)	H (in.)	Cubic Feet (ft <sup>3</sup> ) /CTN	lb/CTN
	BM1-1/4	Batten Molding - 96"W x 1-1/4"H x 1/4"D	97 1/2	8 1/2	2 1/4	1.03	1.76
							
TOE KICK	ITEM	Description	L (in.)	W (in.)	H (in.)	Cubic Feet (ft <sup>3</sup> ) /CTN	lb/CTN
	TK8	Toe Kick Plate - 96"W x 4-1/2"H x 1/4"D	97 1/2	6 1/2	5	1.87	1.76
							
QUATER ROUND MOLDING	ITEM	Description	L (in.)	W (in.)	H (in.)	Cubic Feet (ft <sup>3</sup> ) /CTN	lb/CTN
	QRM	Shoe Molding - 96"W x 3/4"H x 3/4"D	97 1/2	5 1/4	4 1/4	1.30	0.71
							
OUTSIDE CORNER MOLDING	ITEM	Description	L (in.)	W (in.)	H (in.)	Cubic Feet (ft <sup>3</sup> ) /CTN	lb/CTN
	OCM8	Outside Corner Molding - 96"W x 7/8"H x 7/8"D	97 1/2	7 3/4	2 3/4	1.19	0.66
							

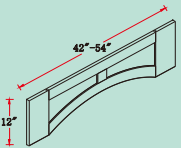
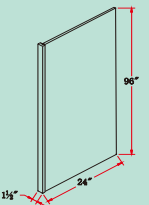
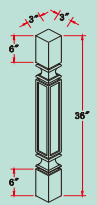
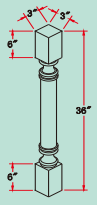
INSIDE CORNER MOLDING	ITEM	Description	L (in.)	W (in.)	H (in.)	Cubic Feet (ft <sup>3</sup> ) /CTN	lb/CTN
	ICM8	Inside Corner Molding - 96"W x 3/4"H x 3/4"D	97 1/2	6	5	1.76	0.35
							
BASEBOARD MOLDING	ITEM	Description	L (in.)	W (in.)	H (in.)	Cubic Feet (ft <sup>3</sup> ) /CTN	lb/CTN
	VST96	Baseboard Molding - 96"W x 5-1/2"H x 3/4"D	97 1/2	7 1/4	4 1/4	1.78	5.38
							
STACKING MOLDING	ITEM	Description	L (in.)	W (in.)	H (in.)	Cubic Feet (ft <sup>3</sup> ) /CTN	lb/CTN
	STKM8	Stacking Molding 96"W x 2-1/2"H x 3/4"D-5/8" D	97 3/4	7	4 1/4	1.69	2.34
							
VALANCE	ITEM	Description	L (in.)	W (in.)	H (in.)	Cubic Feet (ft <sup>3</sup> ) /CTN	lb/CTN
	VAR36	Valance - 36"W x 5-1/2"H x 3/4"D	37 1/2	7 1/4	4 1/4	0.68	2.65
	VAR54	Valance - 54"W x 5-1/2"H x 3/4"D	55 1/4	7 1/4	4 1/4	1.01	3.68
							

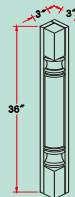
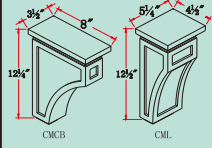
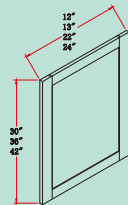
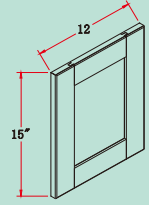
VALANCE	ITEM	Description	L (in.)	W (in.)	H (in.)	Cubic Feet (ft <sup>3</sup> ) /CTN	lb/CTN
	VARP42	Valance w/ Raised Panel 42" Trimable to 36" - 42"W x 12"H x 3/4"D	43 3/4	14 1/4	1 1/2	0.49	7.72
	VARP54	Valance w/ Raised Panel 54" Trimable to 48" - 54"W x 12"H x 3/4"D	55 3/4	14 1/4	1 1/2	0.63	9.26
REFRIGERATOR END PANEL	ITEM	Description	L (in.)	W (in.)	H (in.)	Cubic Feet (ft <sup>3</sup> ) /CTN	lb/CTN
	REP2496	Refrigerator End Panel - 24"W x 96"H x 1-1/2"D	97 1/2	26	2 1/4	3.46	30.64
POST	ITEM	Description	L (in.)	W (in.)	H (in.)	Cubic Feet (ft <sup>3</sup> ) /CTN	lb/CTN
	SP336	Square Roman Pillar- 03"W x 36"H x 03"D	37 1/2	8	3 1/4	0.58	4.19
POST	ITEM	Description	L (in.)	W (in.)	H (in.)	Cubic Feet (ft <sup>3</sup> ) /CTN	lb/CTN
	RP336	Round Roman Pillar- 03"W x 36"H x 03"D	37 3/4	7 3/4	3 1/4	0.56	3.64
	RP436	Round Roman Pillar- 04"W x 36"H x 04"D	37 3/4	10 3/4	5	1.17	6.72

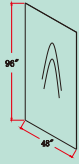
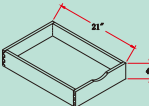
POST	ITEM	Description	L (in.)	W (in.)	H (in.)	Cubic Feet (ft <sup>3</sup> ) /CTN	lb/CTN
	CP36	Corner Roman Pillar- 03"W x 36"H x 03"D	37 3/4	7 3/4	3 1/4	0.56	4.08
CORBELS	ITEM	Description	L (in.)	W (in.)	H (in.)	Cubic Feet (ft <sup>3</sup> ) /CTN	lb/CTN
	CMCB	Corbel - 3-1/2"W x 12-1/4"H x 08"D	13 1/2	9 3/4	4	0.30	3.31
	CML	Corbel - 5-1/4"W x 12-1/2"H x 4-1/2"D	14	7 1/4	5 1/4	0.31	3.17
WAINSCOT PANEL	ITEM	Description	L (in.)	W (in.)	H (in.)	Cubic Feet (ft <sup>3</sup> ) /CTN	lb/CTN
	WP-BASE	Wainscot Panel Base - 23-1/2"W x 29-1/2"H x 3/4"D	31 1/2	26	1 1/2	0.66	11.02
	WP-W30	Wainscot Panel Wall 30" - 11-1/2"W x 29-1/2"H x 3/4"D	31 3/4	14	1 1/2	0.36	6.61
	WP-W36	Wainscot Panel Wall 36" - 11-1/2"W x 35-1/2"H x 3/4"D	37 3/4	14	1 1/2	0.42	7.05
	WP-W42	Wainscot Panel Wall 42" - 11-1/2"W x 41-1/2"H x 3/4"D	43 3/4	14	1 1/2	0.49	7.50
SAMPLE DOOR	ITEM	Description	L (in.)	W (in.)	H (in.)	Cubic Feet (ft <sup>3</sup> ) /CTN	lb/CTN
	SD	Sample Door - 12"W x 15"H x 3/4"D	16 3/4	14 1/4	4 1/4	0.59	14.33

BASE END SKIN PANEL	ITEM	Description	L (in.)	W (in.)	H (in.)	Cubic Feet (ft <sup>3</sup> ) /CTN	lb/CTN
	BP3496-1/4	End Skin Panel (Plywood) - 34-1/2"W x 96"H x 1/4"D	97 1/2	36 1/2	1 1/2	2.84	17.86
BASE END SKIN PANEL	ITEM	Description	L (in.)	W (in.)	H (in.)	Cubic Feet (ft <sup>3</sup> ) /CTN	lb/CTN
	BP4896-1/4	End Skin Panel - 48"W x 96"H x 1/4"D	97 1/2	50 1/4	1 1/2	3.90	24.47
	BP4896-1/2	End Skin Panel - 48"W X 96"H X 1/2"D	97 1/2	50 1/4	1 1/4	3.34	55.12
	BP4896-3/4	End Skin Panel - 48"W X 96"H X 3/4"D	97 1/2	50 1/4	1 1/4	3.34	66.14
	BP2496-3/4	End Skin Panel - 24"W X 96"H X 3/4"D					
ROLL OUT TRAY	ITEM	Description	L (in.)	W (in.)	H (in.)	Cubic Feet (ft <sup>3</sup> ) /CTN	lb/CTN
	RD15	Roll Out Tray - 15" Drawer Box	25	12	2	0.34	10.19
	RD18	Roll Out Tray - 18" Drawer Box	25	15 1/4	2	0.43	11.18
	RD21	Roll Out Tray - 21" Drawer Box	25	18	2	0.51	11.90
	RD24	Roll Out Tray - 24" Drawer Box	25	21	2	0.60	13.05
	RD27	Roll Out Tray - 27" Drawer Box	26 1/2	22	2	0.67	14.09
	RD30	Roll Out Tray - 30" Drawer Box	29 1/4	22	2	0.74	15.17
	RD33	Roll Out Tray - 33" Drawer Box	32 1/2	22	2	0.82	15.70
	RD36	Roll Out Tray - 36" Drawer Box	35 1/2	22	2	0.89	17.06
TOUCH UP KIT	ITEM	Description	L (in.)	W (in.)	H (in.)	Cubic Feet (ft <sup>3</sup> ) /CTN	lb/CTN
	TOUCH	Touch Up Kit					



CABINETS, COUNTERTOPS & MORE

📞 346-582-3082

✉️ [upccmore@gmail.com](mailto:upccmore@gmail.com)

📍 1325 Main St. Suite 303  
Katy, TX 77494

🌐 [www.upcabinetscountertops.com](http://www.upcabinetscountertops.com)

# SELECT SERIES



True White



Natural Oak



Light Grey

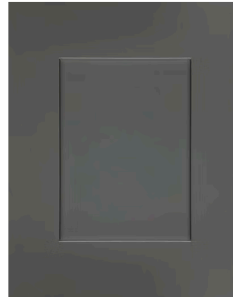

Grey

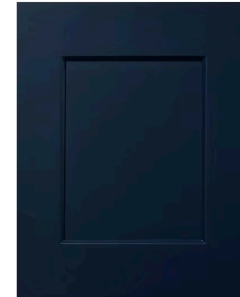

Deep Blue



Slim Green

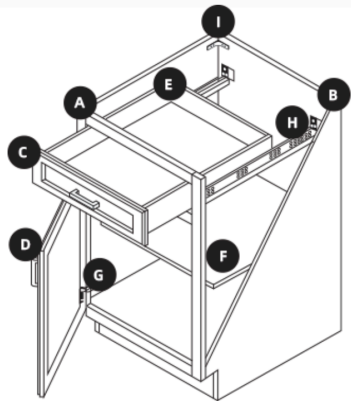

- A.** 3/4" solid wood faceframe
- B.** 1/2" high grade plywood box with matching interior finish
- C.** 3/4" drawer panel\*
- D.** 3/4" door panel\*
- E.** 5/8" rubberwood dovetailed drawer box
- F.** Full depth adjustable plywood shelf
- G.** Adjustable soft-close concealed hinges
- H.** Undermounted soft-close drawer slides
- I.** Reinforced metal Corner brackets

\* Materials vary across different door styles.



Solid wood doors & drawers

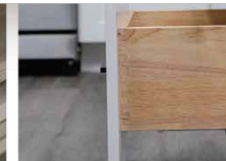

Dovetailed wood drawer box



Plywood box construction



3/4" solid wood faceframe



Matching color interior



Soft-close door hinge



Soft-close drawer slide



CARB2 & TSCA Compliant

## Framed Cabinets with Classic Box



TRUE WHITE

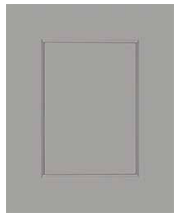









LIGHT GREY

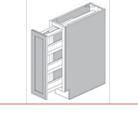

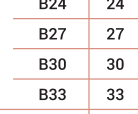
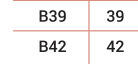
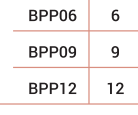

GREY

### BASE FULL DOOR / DOOR & DRAWER CABINET

	Model	W	H	D
	B09F	9	34 1/2	24
	B12	12	34 1/2	24
	B15	15	34 1/2	24
	B18	18	34 1/2	24
	B21	21	34 1/2	24
	B24	24	34 1/2	24
	B27	27	34 1/2	24
	B30	30	34 1/2	24
	B33	33	34 1/2	24
	B36	36	34 1/2	24
	B39	39	34 1/2	24
	B42	42	34 1/2	24



### BASE SPICE RACK CABINET

	Model	W	H	D
	BPP06	6	34 1/2	24
	BPP09	9	34 1/2	24
	BPP12	12	34 1/2	24





### BASE END SHELF CABINET

	Model	W	H	D
	BES09	9	34 1/2	24

### FULL DOOR CABINET/ BLIND CORNER BASE CABINET



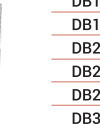

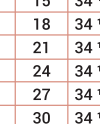
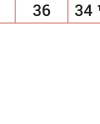



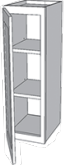

	Model	W	H	D
	BBC36F	36	34 1/2	24
	BBC39	39	34 1/2	24
	BBC42	42	34 1/2	24

### DRAWER BASE CABINET

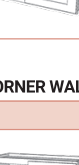



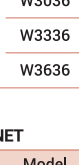

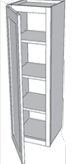

	Model	W	H	D
	DB12	12	34 1/2	24
	DB15	15	34 1/2	24
	DB18	18	34 1/2	24
	DB21	21	34 1/2	24
	DB24	24	34 1/2	24
	DB27	27	34 1/2	24
	DB30	30	34 1/2	24
	DB36	36	34 1/2	24

## Framed Cabinets with Classic Box

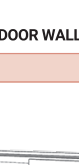

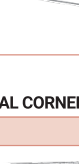

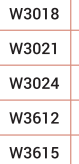
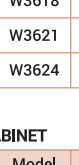



### 30" H SINGLE DOOR/ DOUBLE DOOR WALL CABINET

	Model	W	H	D
	W0930	9	30	12
	W1230	12	30	12
	W1530	15	30	12
	W1830	18	30	12
	W2130	21	30	12
	W2430	24	30	12
	W2730	27	30	12
	W3030	30	30	12
	W3330	33	30	12
	W3630	36	30	12
	W3930	39	30	12

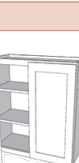





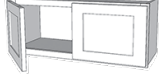

### 40" H SINGLE DOOR/ DOUBLE DOOR WALL CABINET

	Model	W	H	D
	W0940	9	40	12
	W1240	12	40	12
	W1540	15	40	12
	W1840	18	40	12
	W2140	21	40	12
	W2440	24	40	12
	W2740	27	40	12
	W3040	30	40	12
	W3340	33	40	12
	W3640	36	40	12
	W3940	39	40	12

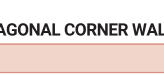

### 36" H SINGLE DOOR/ DOUBLE DOOR WALL CABINET

	Model	W	H	D
	W0936	9	36	12
	W1236	12	36	12
	W1536	15	36	12
	W1836	18	36	12
	W2136	21	36	12
	W2436	24	36	12
	W2736	27	36	12
	W3036	30	36	12
	W3336	33	36	12
	W3636	36	36	12



### DOUBLE DOOR WALL CABINET (ABOVE RANGE/ REFRIGERATOR)

	Model	W	H	D
	W3012	30	12	12
	W3015	30	15	12
	W3018	30	18	12
	W3021	30	21	12
	W3024	30	24	12
	W3612	36	12	12
	W3615	36	15	12
	W3618	36	18	12
	W3621	36	21	12
	W3624	36	24	12

### BLIND CORNER WALL CABINET

	Model	W	H	D
	WBC2730	27	30	12
	WBC2736	27	36	12
	WBC2740	27	40	12

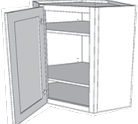
### DIAGONAL CORNER WALL CABINET

	Model	W	H	D
	WDC2430	24	30	12
	WDC2436	30	36	12
	WDC2440	36	40	12

## Framed Cabinets with Classic Box

### EASY REACH WALL CABINET

Model	W	H	D
WER2430	24	30	12
WER2436	24	36	12
WER2440	24	40	12

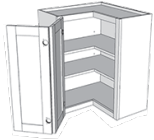

### TALL SINGLE DOOR PANTRY CABINET BASE & TOP

Model	W	H	D
PC1830T	18	30	24
PC1836T	18	36	24
PC1840T	18	40	24
PC1854B	18	54	24

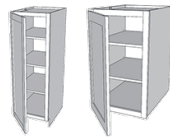

## Framed Cabinets with Classic Box

### LAZY SUSAN BASE CABINET

Model	W	H	D
BLS33/LAZ33	33	34 1/2	24
BLS36/LAZ36	36	34 1/2	24

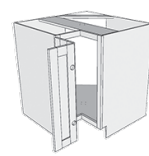

### WALL MICROWAVE CABINET

Model	W	H	D
WMC2730	27	30	12
WMC2736	27	36	12
WMC2740	27	40	12

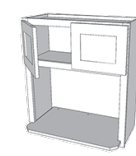

### TALL DOUBLE DOOR PANTRY CABINET BASE & TOP

Model	W	H	D
PC2430T	24	30	24
PC2436T	24	36	24
PC2440T	24	40	24
PC2454B	24	54	24
PC3036T	30	36	24
PC3040T	30	40	24
PC3054B	30	54	24

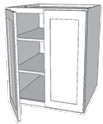
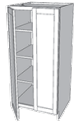

### OVEN CABINET BASE & TOP

Model	W	H	D
OVD3112T	31	12	24
OVD3118T	31	18	24
OVD3122T	31	22	24
OVD3312T	33	12	24
OVD3318T	33	18	24
OVD3322T	33	22	24
OVD3172B	31	72	24
OVD3372B	33	72	24

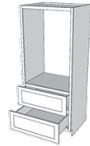
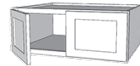

### DOUBLE DOORS WALL CABINET (ABOVE REFRIGERATOR)

Model	W	H	D
W301224	30	12	24
W301524	30	15	24
W301824	30	18	24
W302124	30	21	24
W302424	30	24	24
W361224	36	12	24
W361524	36	15	24
W361824	36	18	24
W362124	36	21	24
W362424	36	24	24

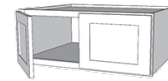

### WALL WINE RACK

Model	W	H	D
WWR3015	30	15	12

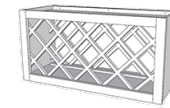

### VANITY 3-DRAWERS BASE

Model	W	H	D
VDB1221	12	34 1/2	21
VDB1521	15	34 1/2	21
VDB1821	18	34 1/2	21
VDB2121	21	34 1/2	21
VDB2421	24	34 1/2	21

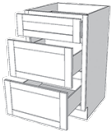

### VANITY SINK BASE WITH DOUBLE DOORS

Model	W	H	D
V2421	24	34 1/2	21
V3021	30	34 1/2	21
V3621	36	34 1/2	21
V3021D	30	34 1/2	21
V3621D	36	34 1/2	21

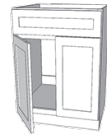

### VANITY SINK BASE WITH DRAWERS

Model	W	H	D
V4821DLR	48	34 1/2	21
V6021DLR	60	34 1/2	21
V6021DC	60	34 1/2	21

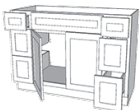

### SINK BASE/ FARMHOUSE SINK BASE

Model	W	H	D
SB30	30	34 1/2	24
SB33	33	34 1/2	24
SB36	36	34 1/2	24
FSB36	36	34 1/2	24

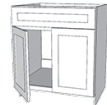

### SINK BASE CORNER

Model	W	H	D
SBC36	36	34 1/2	24
SBC42	42	34 1/2	24

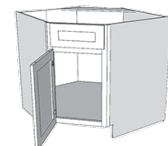





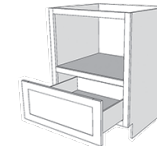

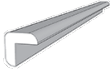

### BASE MICROWAVE CABINET

Model	W	H	D
BMC27	27	34 1/2	24
BMC30	30	34 1/2	24



## Cabinets Accessories

Model	Descriptions	Model	Descriptions
	WF330 Wall/ Base Filler 3" x 30"		OCM Outside Corner Moulding 3/4" x 1/8" x 96"
WF340 Wall/ Base Filler 3" x 40"			
WF640 Wall/ Base Filler 6" x 40"			
TF1.5 Tall Filler 1 1/2" x 96"			
TF396 Tall Filler 3" x 96"			
TF696 Tall Filler 6" x 96"			
	BFD2430 Base Fake Door Panel 24" x 30"		ROT18 ROT21 ROT24 ROT27 ROT30 ROT33 ROT36 Roll Out Tray w/Soft-Close Slides Apply to 18"W-36"W Frameless Cabinet
WFD1230 Wall Fake Door Panel 12" x 30"			
WFD1236 Wall Fake Door Panel 12" x 36"			
WFD1240 Wall Fake Door Panel 12" x 40"			
	CM2-CURVE Crown Moulding Curve 2"		RR96 (24 x 96 x 1/2) Refrigerator Panel Skin Panel 24" x 96" x 1/8" Island Skin Panel 34.5" x 96" x 1/8"
CM4-CURVE Crown Moulding Curve 4"			
CM2-FLAT Crown Moulding Flat 2"			
	CM3-FLAT Crown Moulding Flat 3"		LM8 Light Moulding 1 3/8" x 7/8" x 96"
TK Toe Kick 4 1/2" x 1/2" x 96"			
	SM Scribe Moulding 3/4" x 1/8" x 96"		MR21 21" x 35" MR27 27" x 35" MR33 33" x 35"

## Framed Cabinets with Natural Box



### FULL DOOR BASE CABINET / DOOR & DRAWER CABINET

Model	W	H	D
 B09F	9	34 1/2	24
B12	12	34 1/2	24
B15	15	34 1/2	24
B18	18	34 1/2	24
B21	21	34 1/2	24
B24	24	34 1/2	24
B27	27	34 1/2	24
B30	30	34 1/2	24
B33	33	34 1/2	24
B36	36	34 1/2	24
B39	39	34 1/2	24
B42	42	34 1/2	24

### BASE SPICE RACK CABINET

Model	W	H	D
 BPP09	9	34 1/2	24

### DRAWER BASE CABINET

Model	W	H	D
 DB12	12	34 1/2	24
DB15	15	34 1/2	24
DB18	18	34 1/2	24
DB21	21	34 1/2	24
DB24	24	34 1/2	24
DB27	27	34 1/2	24
DB30	30	34 1/2	24
DB36	36	34 1/2	24

### FULL DOOR CABINET/ BLIND CORNER BASE CABINET

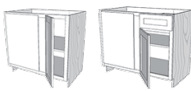
Model	W	H	D
 BBC36F	36	34 1/2	24
BBC39	39	34 1/2	24
BBC42	42	34 1/2	24

### OVEN CABINET BASE

Model	W	H	D
 OVD3312T	33	12	24
OVD3318T	33	18	24
OVD3322T	33	22	24
OVD3372B	33	72	24

### TALL SINGLE DOOR PANTRY CABINET BASE & TOP

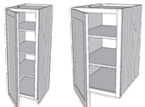
Model	W	H	D
 PC1830T	18	30	24
PC1836T	18	36	24
PC1842T	18	40	24
PC1854B	18	54	24

### TALL DOUBLE DOOR PANTRY CABINET BASE & TOP

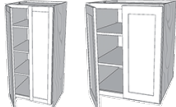
Model	W	H	D
 PC2430T	24	30	24
PC2436T	24	36	24
PC2442T	24	42	24
PC2454B	24	54	24
PC3030T	30	30	24
PC3036T	30	36	24
PC3042T	30	42	24
PC3054B	30	54	24

## Framed Cabinets with Natural Box

### SINK BASE/ FARMHOUSE SINK BASE

	Model	W	H	D
	SB30	30	34 1/2	24
	SB33	33	34 1/2	24
	SB36	36	34 1/2	24
	FSB36	36	34 1/2	24

### VANITY SINK BASE WITH DOUBLE DOOR

	Model	W	H	D
	V2421	24	34 1/2	21
	V3021	30	34 1/2	21
	V3621	36	34 1/2	21
	V3021D	30	34 1/2	21
	V3621D	36	34 1/2	21

### 30" H SINGLE DOOR/ DOUBLE DOOR WALL CABINET

	Model	W	H	D
	W0930	9	30	12
	W1230	12	30	12
	W1530	15	30	12
	W1830	18	30	12
	W2130	21	30	12
	W2430	24	30	12
	W2730	27	30	12
	W3030	30	30	12
	W3330	33	30	12
	W3630	36	30	12
	W3930	39	30	12

### 36" H SINGLE DOOR/ DOUBLE DOOR WALL CABINET

	Model	W	H	D
	W0936	9	36	12
	W1236	12	36	12
	W1536	15	36	12
	W1836	18	36	12
	W2136	21	36	12
	W2436	24	36	12
	W2736	27	36	12
	W3036	30	36	12
	W3336	33	36	12
	W3636	36	36	12

### VANITY SINK BASE WITH DRAWERS

	Model	W	H	D
	V4821DLR	48	34 1/2	21

### VANITY SINK BASE WITH DOUBLE DOOR

	Model	W	H	D
	VDB1221	12	34 1/2	21
	VDB1521	15	34 1/2	21
	VDB1821	18	34 1/2	21
	VDB2121	21	34 1/2	21

### 42" H SINGLE DOOR/ DOUBLE DOOR WALL CABINET

	Model	W	H	D
	W0942	9	42	12
	W1242	12	42	12
	W1542	15	42	12
	W1842	18	42	12
	W2142	21	42	12
	W2442	24	42	12
	W2742	27	42	12
	W3042	30	42	12
	W3342	33	42	12
	W3642	36	42	12
	W3942	39	42	12

### DOUBLE DOOR WALL CABINET(ABOVE RANGE/ REFRIGERATOR)

	Model	W	H	D
	W3012	30	12	12
	W3015	30	15	12
	W3018	30	18	12
	W3021	30	21	12
	W3024	30	24	12
	W3612	36	12	12
	W3615	36	15	12
	W3618	36	18	12
	W3621	36	21	12
	W3624	36	24	12

## Framed Cabinets with Natural Box

### DOUBLE DOOR WALL CABINET(ABOVE REFRIGERATOR)

	Model	W	H	D
	W301224	30	12	24
	W301524	30	15	24
	W301824	30	18	24
	W302124	30	21	24
	W302424	30	24	24
	W361224	36	12	24
	W361524	36	15	24
	W361824	36	18	24
	W362124	36	21	24
	W362424	36	24	24

### EASY REACH WALL CABINET

	Model	W	H	D
	WER2430	24	30	12
	WER2436	24	36	12
	WER2442	24	42	12

### WALL MICROWAVE CABINET

	Model	W	H	D
	WMC2730	27	30	12
	WMC2736	27	36	12
	WMC2742	27	42	12

### LAZY SUSAN BASE CABINET

	Model	W	H	D
	BLS33/LAZ33	9	34 1/2	24
	BLS36/LAZ36	9	34 1/2	24

### BASE MICROWAVE CABINET

	Model	W	H	D
	BMC27	27	34 1/2	24
	BMC30	30	34 1/2	24

### BLIND CORNER WALL CABINET

	Model	W	H	D
	WBC2730	27	30	12
	WBC2736	27	36	12
	WBC2742	27	42	12

### DIAGONAL CORNER WALL CABINET

	Model	W	H	D
	WDC2430	24	30	12
	WDC2436	24	36	12
	WDC2442	24	42	12

### WALL END SHELF CABINET

	Model	W	H	D
	WES0630	6/9	30	12
	WES0636	6/9	36	12
	WES0642	6/9	42	12









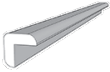

### WALL WINE RACK

	Model	W	H	D
	WWR3015	30	15	12

### SINK BASE CORNER

	Model	W	H	D
	SBC33	33	34 1/2	24
	SBC36	36	34 1/2	24
	SBC42	42	34 1/2	24

## Cabinets Accessories

Model	Descriptions	Model	Descriptions
	WF330 Wall/ Base Filler 3" x 30"		SM Scribe Moulding (3/4" x 1/8" x 8')
	WF340 Wall/ Base Filler 3" x 40"		
	WF640 Wall/ Base Filler 6" x 40"		OCM Outside Corner Moulding (3/4" x 1/8" x 8')
	TF1.5 Tall Filler 1 1/2" x 96"		
	TF396 Tall Filler 3" x 96"		DWR Dishwasher Panel with 1.5 Filler
	TF696 Tall Filler 6" x 96"		
	BFD2430 Base Fake Door Panel 24" x 30"		
	WFD1230 Wall Fake Door Panel 12" x 30"		
	WFD1236 Wall Fake Door Panel 12" x 36"		
	WFD1240 Wall Fake Door Panel 12" x 40"		
	CM2-CURVE Crown Moulding Curve 2"		
	CM4-CURVE Crown Moulding Curve 4"		FP24 Skin Panel 24" x 96" x 1/8"
			FP34.5 Island Skin Panel 34.5" x 96" x 1/8"
			RR96 Refrigerator Panel 24" x 96" x 1/2"
	CM2-FLAT Crown Moulding Flat 2"		FPB Finish Panel Base 34.5" x 24" x 1/8"
	CM3-FLAT Crown Moulding Flat 3"		FPW Finish Panel Wall 12" x 42" x 1/8"
	TK Toe Kick		LAZ33 Two Shelf Metal Wire Lazy Susan Set
			LAZ36 Apply to Cabinet BLS33/BLS36



**CABINETS, COUNTERTOPS & MORE**

 **346-582-3082**

 **upccmore@gmail.com**

 **1325 Main St. Suite 303  
Katy, TX 77494**

 **www.upcabinetscountertops.com**